

Linear System Screen

“The Linear System Series places people at its center, being a place to meet, to collaborate or to work in focused solitude. The design process was about creating a system that made for intimately welcoming atmospheres, enhanced by the expression and functionality of its lighting and accessories. With its warm materiality and modern expression, the Linear System Series brings feelings of home into larger spaces to give the user a sense of belonging, even if being there only for a little while. The extensive selection of lighting and accessories means that the Linear System Series can be configured and reshuffled for any purpose of the modern workplace as well as hospitality settings and public areas, arraying the ideas of aesthetic and function into one.”

— Thomas Bentzen



Designed by	Thomas Bentzen / 2020
About the designer	Thomas Bentzen, former Head of Design at Muuto, started his own studio in 2010. Bentzen's designs are characterized by simplicity, rationality and functionality — always firmly rooted in the Danish design tradition, material knowledge, craftsmanship and rational industrial manufacturing processes. His work continues to receive international recognition at fairs and exhibitions all over the world.
Environment	Indoor
Country of Production	Latvia
Preassembled	Yes - Mount to configuration.
Description	The Linear System Screen creates intimate atmospheres without shielding one from the outside world alongside the subtle functionality of its integrated feet on both sides for storing smaller objects. Can be used either freestanding or mounted onto the Linear System Series.
Material	Screens are in solid oak and veneered MDF with powder coated aluminum fixing knobs. Possibility of upholstery on Screens.
Cleaning & Care	Wooden surface: Clean with a damp cloth. If necessary, only use a mild detergent or washing up liquid and not concentrated. Always wipe with a dry cloth afterwards. To minimize the risk of stains and marks, liquid, grease etc. should be removed straight away. Textile: Remove non-greasy stains by carefully dabbing with a lint-free cloth wrung out in clean, warm water. If necessary, clean by dabbing with soapy water. Visit Kvadrat.dk for further information on cleaning textiles.

Linear System Screen

Dimensions

125 cm / 49.2"

Length: 125 cm / 49.2"
Height: 35 cm / 13.8"
Width: 15 cm / 5.9"



178 cm / 70.1"

Length: 178 cm / 70.1"
Height: 35 cm / 13.8"
Width: 15 cm / 5.9"



75 cm / 29.5"

Length: 75 cm / 29.5"
Height: 35 cm / 13.8"
Width: 15 cm / 5.9"

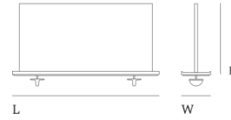

Ready-to-ship

Oak
Black



Made-to-order

This product can be upholstered in the following textiles: Balder, Canvas, Clara, Clay, Divina, Divina MD, Divina Melange, Ecriture, Fiord, Hallingdal, Hero, Ocean, Planum, Remix, Re-wool, Sabi, Steelcut, Steelcut Trio, Twill Weave, Vidar, Wooly

Tests, Labels & Certifications

Eco-Labels & Certificates VOC — Bifma X 7.1
VOC — CDPH 01350

Strength, Durability & Stability EN 15372-L2 & -L3 Furniture

[Explore Assets](#)

[DOWNLOADSITE](#)

LINEAR SYSTEM SERIES—ORDER GUIDE

The Linear System Series brings a new perspective to the evolving needs of the modern workspaces, hospitality settings and educational institutions through its configurable design across tables, lighting, screens and trays alongside its custom integrated power solution, allowing one to tailor the design to the exact needs of any space.

Option A — Choose between one of our predesigned table configurations and simply add your desired lamps and accessories.

Option B — Create your own configuration from scratch and add lamps and accessories from there. [Scroll down 6 pages.](#)

Option A — Predesigned Table Configurations

STEP 1. TABLES

Select either the Linear System Table or one of three Linear System Table Configurations.

Note
Different finishes of tabletops cannot be mixed as they might vary in thickness.

Linear System Table

Height — 74 cm / 29.1"
Table top width — 142 cm / 55.9"
Total width — 146.9 cm / 57.8"
Total length — 240 cm / 94.5"
No of Persons — 4-6

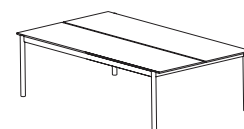

240 cm / 94.5"

Linear System Table Configuration 1

Height — 74 cm / 29.1"
Table top width — 142 cm / 55.9"
Total width — 146.9 cm / 57.8"
Total length — 360 cm / 141.7"
No of Persons — 6-8

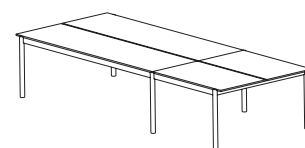

240 cm / 94.5" 120 cm / 47.2"

Linear System Table Configuration 2

Height — 74 cm / 29.1"
Table top width — 142 cm / 55.9"
Total width — 146.9 cm / 57.8"
Total length — 480 cm / 189"
No of Persons — 8-12

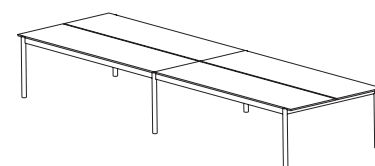

240 cm / 94.5" 240 cm / 94.5"

Linear System Table Configuration 3

Height — 74 cm / 29.1"
Table top width — 142 cm / 55.9"
Total width — 146.9 cm / 57.8"
Total length — 720 cm / 283.5"
No of Persons — 12-18

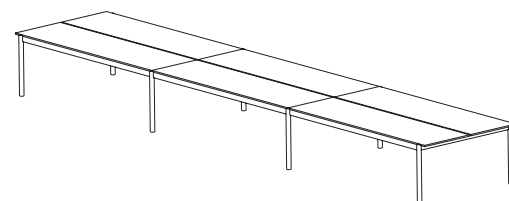

240 cm / 94.5" 240 cm / 94.5" 240 cm / 94.5"

OPTION A

[1. TABLES](#) / [2. ACCESSORIES](#) / [3. LIGHTING](#) / [4. TABLE POWER OUTLET](#) / [5. INTEGRATED POWER](#) / [6. CABLE TRAY](#)

PRICE LIST
FOR MORE INFORMATION, VISIT MUUTO.COM

MUUTO

LINEAR SYSTEM SERIES—ORDER GUIDE

STEP 2. ACCESSORIES

Trays

Add your desired number of Linear System Trays.

Note

Trays must be mounted at least 5 cm / 2" from the table edge.

Linear System Tray — Ø24 cm / 9.5"

Height — 15,6 cm / 6.2"
Diameter — 24 cm / 9.5"



Linear System Tray — Ø36 cm / 14.2"

Height — 9,6 cm / 3.8"
Diameter — 36 cm / 14.2"



Linear System Tray — 170 cm / 66.9"

Height — 15 cm / 5.9"
Width — 21 cm / 8.3"
Length — 170 cm / 66.9"

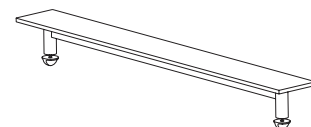

Screens

Add your desired number of Linear System Screens.

Note

We recommend that screens are mounted to the table. They must be placed at least 5 cm / 2" from the table edge.

Linear System Screen — 75 cm / 29.5"

Height — 35 cm / 13.8"
Width — 15 cm / 5.9"
Length — 75 cm / 29.5"

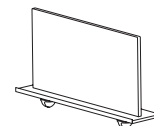

Linear System Screen — 125 cm / 49.2"

Height — 35 cm / 13.8"
Width — 15 cm / 5.9"
Length — 125 cm / 49.2"

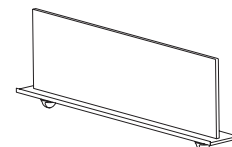

Linear System Screen — 178 cm / 70.1"

Height — 35 cm / 13.8"
Width — 15 cm / 5.9"
Length — 178 cm / 70.1"

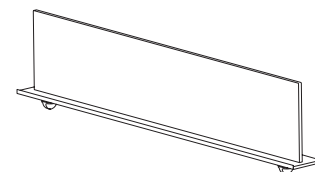

Note

Please note that only the Linear System Screen 125 cm / 49.2" can be mounted across the table.

Example

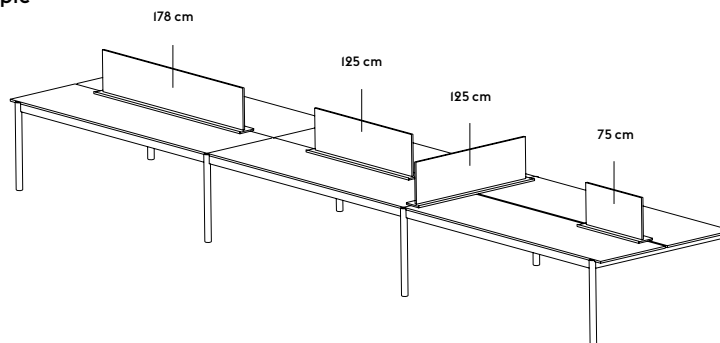

OPTION A

1. TABLES / 2. ACCESSORIES / 3. LIGHTING / 4. TABLE POWER OUTLET / 5. INTEGRATED POWER / 6. CABLE TRAY

LINEAR SYSTEM SERIES—ORDER GUIDE

STEP 3. LIGHTING

Add your desired number of Linear Lamps.

Note
The Linear Table Lamp has one USB-C plug.

Linear Table Lamp

Height — 36,5 cm / 14.4"
Width — 23,2 cm / 9.1"
Depth — 16,5 cm / 6.5"



Note
Linear Mounted Lamp must be mounted at least 5 cm / 2" from the table edge.

Please be aware that the Linear Mounted Lamp and Table Power Outlet, both designed for the Linear System Series, have a special power solution with special plugs. See more on page 4

Linear Mounted Lamp — 23,2 cm / 9.1"

Height — 36,5 cm / 14.4"
Width — 23,2 cm / 9.1"
Depth — 10,7 cm / 4.2"

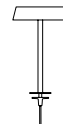

Linear Mounted Lamp — 209,2 cm / 82.4"

Height — 70,7 cm / 27.8"
Width — 209,2 cm / 82.4"
Depth — 10,7 cm / 4.2"



Linear Pendant Lamp — 87,2 cm / 34.3"

Height — 5,4 cm / 2.1"
Width — 87,2 cm / 34.3"
Depth — 10,7 cm / 4.2"



Linear Pendant Lamp — 169,2 cm / 66.6"

Height — 5,4 cm / 2.1"
Width — 169,2 cm / 66.6"
Depth — 10,7 cm / 4.2"



STEP 4. TABLE POWER OUTLETS

Specify your desired number of Table Power Outlets. Each Table Power Outlet has two outlets (one at each end) and one USB-A and USB-C plug to which standard plugs can be connected. Kindly remember to select your region-specific version.

Note
Linear System Table Power Outlet must be mounted at least 5 cm / 2" from the table edge.

Linear System Table Power Outlet — EU, UK

Height — 7 cm / 2.8"
Width — 7 cm / 2.8"
Length — 18 cm / 7.1"

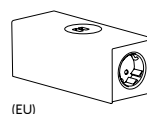

(EU)

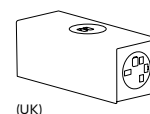

(UK)

OPTION A

1. TABLES / 2. ACCESSORIES / 3. LIGHTING / 4. TABLE POWER OUTLET / 5. INTEGRATED POWER / 6. CABLE TRAY

PRICE LIST
FOR MORE INFORMATION, VISIT MUUTO.COM

MUUTO

LINEAR SYSTEM SERIES—ORDER GUIDE

STEP 5. INTEGRATED POWER FOR MOUNTED LAMPS & TABLE POWER OUTLETS

If you'd like to add the Mounted Lamp(s) or Table Power Outlet(s), select the Table Power Kit for the Linear System Table or one of the three Power Configurations that match your selected Linear System Table Configuration. Kindly remember to select the region-specific power kit.

Note
Each Distribution Block has five outlets to which up to five Linear Mounted Lamps or Linear System Table Power Outlets can be plugged in.

The Extension Kit must be connected to the Power Kit. An Extension Kit has no standard plug.

Distribution Block — 5-way

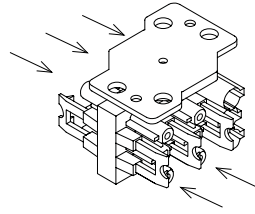

EU cable
1,5 M cable

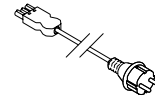

UK cable
1,5 M fused plug

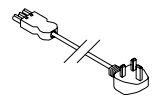

Linear System Table

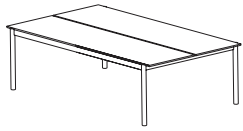

Linear System Power

Power Kit (1 pcs)
150 cm / 59" cable (EU or UK)
Distribution Block

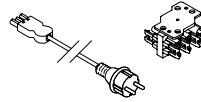

Linear System Table Configuration 1

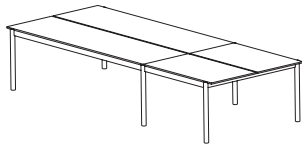

Linear System Power Configuration 1

Power Kit (1 pcs)
150 cm / 59" cable (EU or UK)
Distribution Block

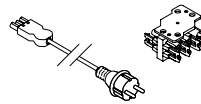

Power Extension Kit — 200 cm (1 pcs)
200 cm / 79" cable
Distribution Block

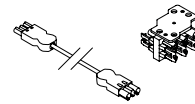

+

Linear System Table Configuration 2

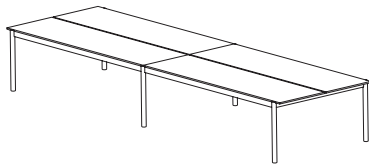

Linear System Power Configuration 2

Power Kit (1 pcs)
150 cm / 59" cable (EU or UK)
Distribution Block

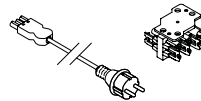

Power Extension Kit — 250 cm (1 pcs)
250 cm / 98" cable
Distribution Block

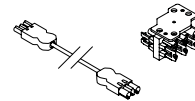

+

Linear System Table Configuration 3

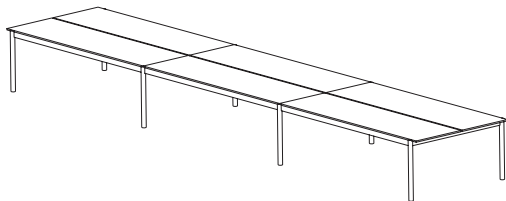

Linear System Power Configuration 3

Power Kit (1 pcs)
150 cm / 59" cable (EU or UK)
Distribution Block

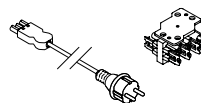

Power Extension Kit — 250 cm (2 pcs)
250 cm / 98" cable
Distribution Block

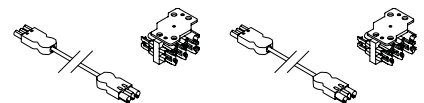

+

OPTION A

1. TABLES / 2. ACCESSORIES / 3. LIGHTING / 4. TABLE POWER OUTLET / 5. INTEGRATED POWER / 6. CABLE TRAY

PRICE LIST
FOR MORE INFORMATION, VISIT MUUTO.COM

MUUTO

LINEAR SYSTEM SERIES—ORDER GUIDE

Note

The Integrated Power for Linear System Series has unique internal plugs to provide a slim and discreet look. This means that you cannot connect a standard plug to the power without using the Linear Table Power Outlet or changing the standard plug to a matching plug, being the Wieland GSTI8I3 plug.

The Linear Mounted Lamps must be connected to the integrated Power Kit.

Wieland GSTI8I3 plug

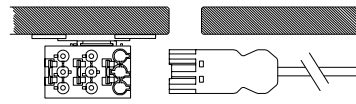

Standard plug (EU or UK)

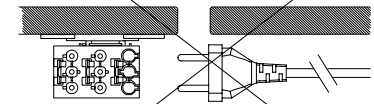

1. Connecting using the Wieland GSTI8I3 plug

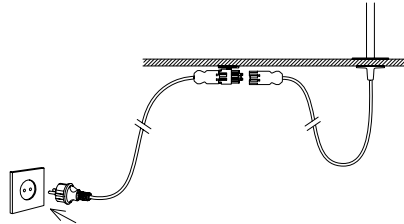

2. Connecting using a standard plug to the Linear Table Power Outlet

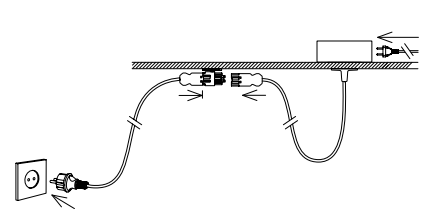

LINEAR TABLE LAMP ONLY

The Linear Table Lamp can either be connected to a standard wall plug or the Table Power Outlet.

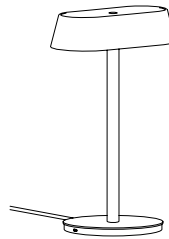

Standard plug

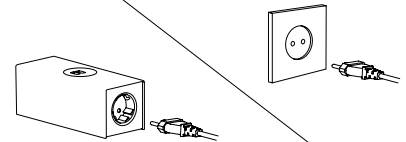

Linear Table Power Outlet

Alternatively, you can connect it to the integrated Power Kit by replacing the plug with a custom Wieland GSTI8I3 plug that is included with the lamp. Kindly refer to the Linear Table Lamp manual for instructions.

Integrated Power Kit (Wieland GSTI8I3 plug)

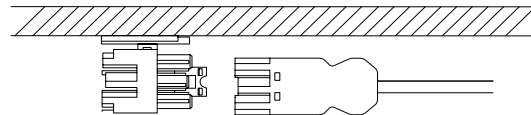

OPTION A

1. TABLES / 2. ACCESSORIES / 3. LIGHTING / 4. TABLE POWER OUTLET / 5. INTEGRATED POWER / 6. CABLE TRAY

PRICE LIST
FOR MORE INFORMATION, VISIT MUUTO.COM

MUUTO

LINEAR SYSTEM SERIES—ORDER GUIDE

STEP 6. CABLE TRAYS

We recommend using 1 Cable Tray for the End Module – 120 cm / 47.2" and up to 3 Cable Trays for the Linear Table, End Module – 240 cm / 94.2" and the Middle Module – 240 cm / 94.2".

Linear System Cable Tray

Height – 3 cm / 1.2"
Width – 22 cm / 8.7"
Depth – 60 cm / 23.7"

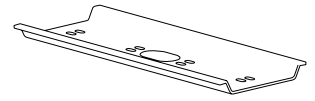

Example:

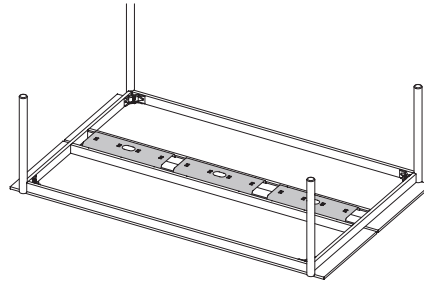

Linear System Table – 240 cm / 94.5"

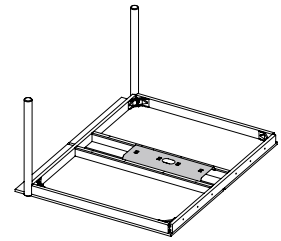

Linear System End Module – 120 cm / 47.2"

OPTION A

1. TABLES / 2. ACCESSORIES / 3. LIGHTING / 4. TABLE POWER OUTLET / 5. INTEGRATED POWER / 6. CABLE TRAY

PRICE LIST
FOR MORE INFORMATION, VISIT MUUTO.COM

MUUTO

LINEAR SYSTEM SERIES—ORDER GUIDE

Option B — Create your own configuration

STEP 1. TABLES

A)

A configuration must always have End Modules in each end.

Start by defining the total length of your desired configuration, then select two table ends.

Note
Different finishes of tabletops cannot be mixed as they might vary in thickness.

Linear System End Module — 240 cm / 94.5"

Height — 74 cm / 29.1"
Width — 146,9 cm / 57.8"
Length — 240 cm / 94.5"
No of Persons — 4-6



Linear System End Module — 120 cm / 47.2"

Height — 74 cm / 29.1"
Width — 146,9 cm / 57.8"
Length — 120 cm / 47.2"
No of Persons — 2



B)

Next, add the second, and final, End Module or your desired number of Middle Modules, only available in 240 cm / 94.5".

Note
Please note that it is not possible to connect more than two End Modules.

Linear System Middle Module — 240 cm / 94.5"

Width — 146,9 cm / 57.8"
Length — 240 cm / 94.5"
No of Persons — 4-6



C)

Next, you must order 1 set of Connecting Legs every time two modules are connected.

Linear System Connecting Legs

Height — 74 cm / 29.1"

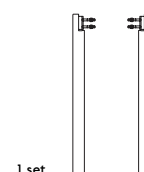

If you'd like a configuration of one End Module — 240 cm / 94.5" and one Middle Module — 240 cm / 94.5" and one End Module — 240 cm / 94.5", you must order two sets of Connecting Legs, as shown in the illustration.

Example

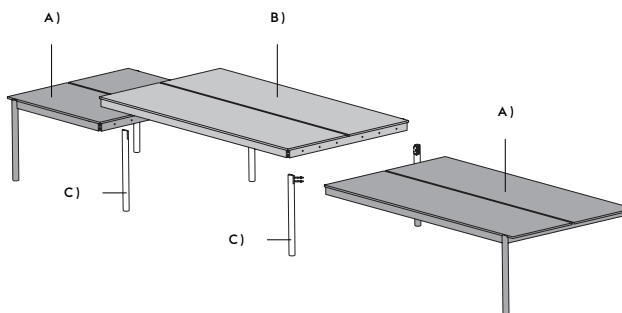

OPTION B

1. TABLES / 2. ACCESSORIES / 3. LIGHTING / 4. TABLE POWER OUTLET / 5. INTEGRATED POWER / 6. CABLE TRAY

LINEAR SYSTEM SERIES—ORDER GUIDE

STEP 2. ACCESSORIES

Trays

Add your desired number of Linear System Trays.

Note
Trays must be mounted at least 5 cm / 2" from the table edge.

Linear System Tray — Ø24 cm / 9.5"

Height — 15,6 cm / 6.2"
Diameter — 24 cm / 9.5"



Linear System Tray — Ø36 cm / 14.2"

Height — 9,6 cm / 3.8"
Diameter — 36 cm / 14.2"



Linear System Tray — 170 cm / 66.9"

Height — 15 cm / 5.9"
Width — 21 cm / 8.3"
Length — 170 cm / 66.9"

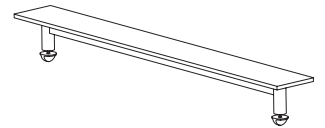

Screens

Add your desired number of Linear System Screens.

Note
We recommend that screens are mounted to the table. They must be placed at least 5 cm / 2" from the table edge.

Linear System Screen — 75 cm / 29.5"

Height — 35 cm / 13.8"
Width — 15 cm / 5.9"
Length — 75 cm / 29.5"

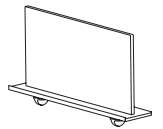

Linear System Screen — 125 cm / 49.2"

Height — 35 cm / 13.8"
Width — 15 cm / 5.9"
Length — 125 cm / 49.2"

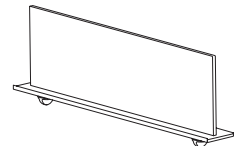

Linear System Screen — 178 cm / 70.1"

Height — 35 cm / 13.8"
Width — 15 cm / 5.9"
Length — 178 cm / 70.1"

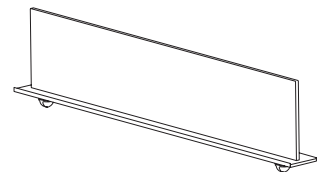

Note
Please note that only the Linear System Screen 125 cm / 49.2" can be mounted across the table.

Example

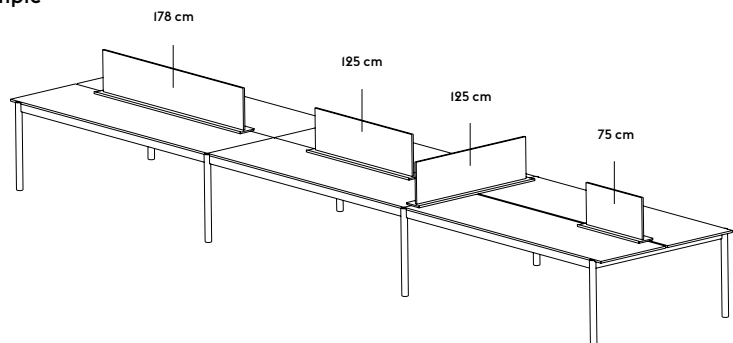

OPTION B

1. TABLES / 2. ACCESSORIES / 3. LIGHTING / 4. TABLE POWER OUTLET / 5. INTEGRATED POWER / 6. CABLE TRAY

PRICE LIST
FOR MORE INFORMATION, VISIT MUUTO.COM

MUUTO

LINEAR SYSTEM SERIES—ORDER GUIDE

STEP 3. LIGHTING

Add your desired number of Linear Lamps.

Note

The Linear Table Lamp has one USB-C plug.

Linear Table Lamp

Height — 36,5 cm / 14.4"
Width — 23,2 cm / 9.1"
Depth — 16,5 cm / 6.5"



Note

Linear Mounted Lamp must be mounted at least 5 cm / 2" from the table edge.

Please be aware that the Linear Mounted Lamp and Table Power Outlet, both designed for the Linear System Series, have a special power solution with special plugs. See more on page 4.

Linear Mounted Lamp — 23,2 cm / 9.1"

Height — 36,5 cm / 14.4"
Width — 23,2 cm / 9.1"
Depth — 10,7 cm / 4.2"

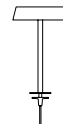

Linear Mounted Lamp — 209,2 cm / 82.4"

Height — 70,7 cm / 27.8"
Width — 209,2 cm / 82.4"
Depth — 10,7 cm / 4.2"



Linear Pendant Lamp — 87,2 cm / 34.3"

Height — 5,4 cm / 2.1"
Width — 87,2 cm / 34.3"
Depth — 10,7 cm / 4.2"



Linear Pendant Lamp — 169,2 cm / 66.6"

Height — 5,4 cm / 2.1"
Width — 169,2 cm / 66.6"
Depth — 10,7 cm / 4.2"



STEP 4. TABLE POWER OUTLETS

Specify your desired number of Table Power Outlets. Each Table Power Outlet has two outlets (one at each end) and one USB-A and USB-C plug to which standard plugs can be connected. Kindly remember to select your region-specific version.

Note

Linear System Table Power Outlet must be mounted at least 5 cm / 2" from the table edge.

Linear System Table Power Outlet — EU, UK

Height — 7 cm / 2.8"
Width — 7 cm / 2.8"
Length — 18 cm / 7.1"

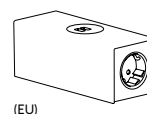

(EU)

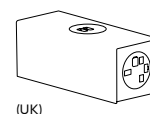

(UK)

OPTION B

1. TABLES / 2. ACCESSORIES / 3. LIGHTING / 4. TABLE POWER OUTLET / 5. INTEGRATED POWER / 6. CABLE TRAY

PRICE LIST
FOR MORE INFORMATION, VISIT MUUTO.COM

MUUTO

LINEAR SYSTEM SERIES—ORDER GUIDE

STEP 5. INTEGRATED POWER FOR MOUNTED LAMPS & TABLE POWER OUTLET

If you'd like to add the Mounted Lamp(s) and/or Table Power Outlet(s), select the Power Kit for the first End Module you choose and then add an a Power Extension Kit for each table added.

Power Kit (1 pcs)

150 cm / 59" cable (EU or UK)
Distribution Block

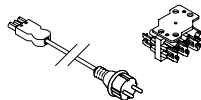

Power Extension Kit (X pcs)

200 cm / 79" or 250 cm / 98" cable
Distribution Block

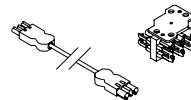

If you add a End Module or a Middle Module — 240 cm / 94.5", select the 250 cm / 98" Power Extension Kit.

If you add a End Module — 120 cm / 47.2", select the 200 cm / 79" Power Extension kit.

Example 1

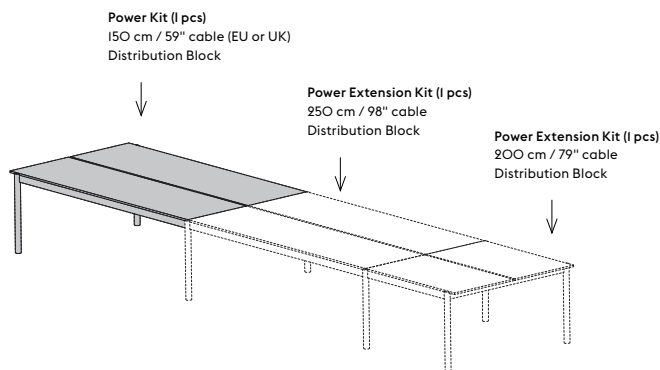

Example 2

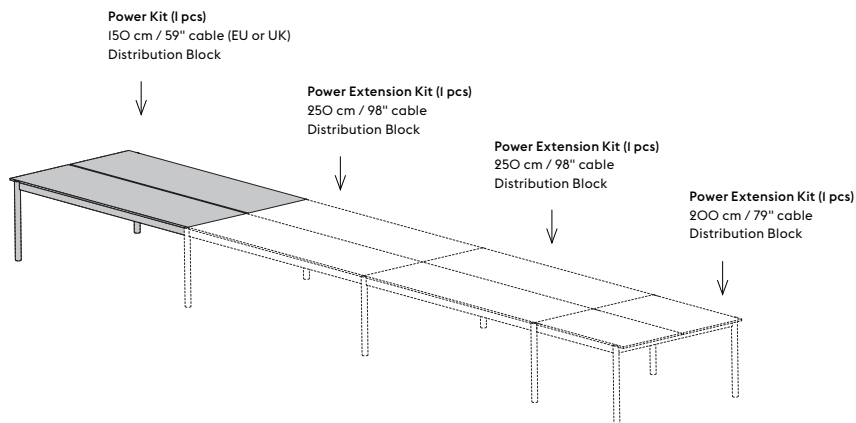

OPTION B

1. TABLES / 2. ACCESSORIES / 3. LIGHTING / 4. TABLE POWER OUTLET / 5. INTEGRATED POWER / 6. CABLE TRAY

LINEAR SYSTEM SERIES—ORDER GUIDE

LINEAR TABLE LAMP ONLY

The Linear Table Lamp can either be connected to a standard wall plug or the Table Power Outlet.

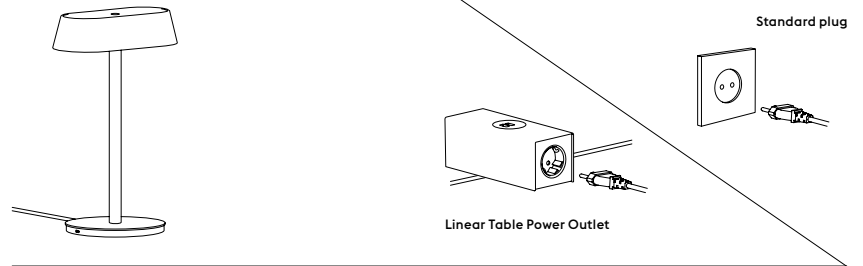

Alternatively, you can connect it to the integrated Table Power Kit by replacing the plug with a custom Wieland GST1813 plug that is included with the lamp. Kindly refer to the Linear Table Lamp manual for instructions.

Integrated Table Power Kit (Wieland GST1813 plug)

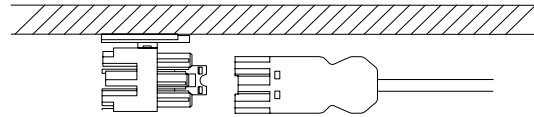

STEP 6. CABLE TRAYS

We recommend using 1 Cable Tray for the End Module – 120 cm / 47.2" and up to 3 Cable Trays for the Linear Table, End Module – 240 cm / 94.2" and the Middle Module – 240 cm / 94.2".

Linear System Cable Tray

Height – 3 cm / 1.2"
Width – 22 cm / 8.7"
Depth – 60 cm / 23.7"

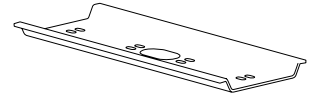

Example:

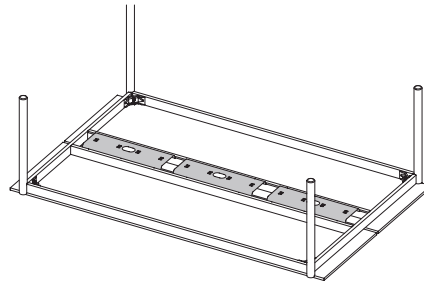

Linear System Table – 240 cm / 94.5"

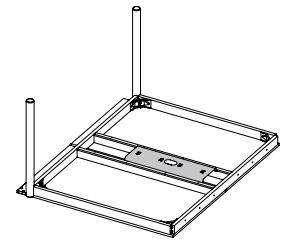

Linear System End Module – 120 cm / 47.2"

OPTION B

1. TABLES / 2. ACCESSORIES / 3. LIGHTING / 4. TABLE POWER OUTLET / 5. INTEGRATED POWER / 6. CABLE TRAY

PRICE LIST
FOR MORE INFORMATION, VISIT MUUTO.COM

MUUTO

